

**CHIAVE PER DADO VARIATORE POSTERIORE
CLEF POUR ECROU VARIATEUR POSTERIEUR
REAR VARIATOR NUT WRENCH**

Art. 5445

ES./HEX. mm. 46
per/pour/for **PIAGGIO 250cc -
YAMAHA 125-150cc**

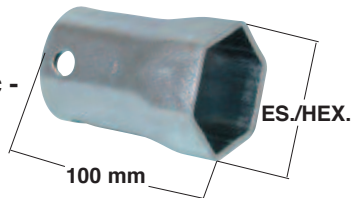

Art. 5449

ES./HEX. mm. 55
per/pour/for **PIAGGIO** da/de/from 300cc a/à/to 500cc

Art. 5658

**ATTREZZO RITEGNO MOLLA FRIZIONE
OUTIL DE RETENTION RESSORT EMBRAYAGE
CLUTCH SPRING CHECK TOOL**

PER MOTORI / POUR MOTEURS / FOR ENGINES
PIAGGIO - VESPA
DA/DE/FROM 125cc
A/À/TO 500cc 4T

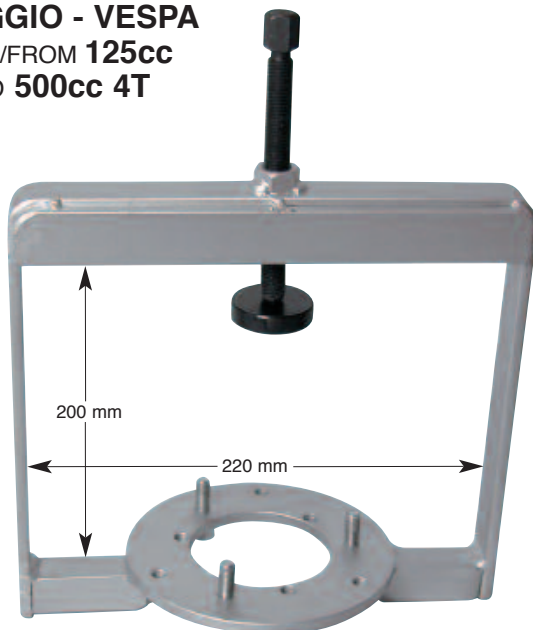

Art. 5666

**ATTREZZO PER METTERE IN CARICA LA MOLLA DEL
SETTORE AVVIAMENTO**

**OUTIL POUR METTRE EN PLACE LA RESSORT DU SECTEUR
DEMARREUR**

TOOL TO REASSEMBLE THE START SHAFT SPRING

per/pour/for **PIAGGIO / VESPA**

Tutti i modelli 2 e 4t da 50 a 125cc
Tous les modèles 2 et 4t de 50 à 125cc
All models 2 and 4s from 50 to 125cc

per/pour/for **PEUGEOT SPEEDFIGHT 3**



**CHIAVI A CANDELA
CLES À BOUGIE
SPARK PLUG SPANNERS**



**CHIAVI PER CANDELE E RUOTE
CLES POUR BOUGIE ET ROUES
SPANNERS FOR PLUG AND WHEEL**

Art. 4870

Es. - hex. mm. 11 x 13 x 21
VESPA SPECIAL model
PRIMAVERA - ET3 model

Art. 4874

Es. - hex. mm. 13 x 17 x 21
VESPA SPECIAL model
PRIMAVERA - ET3 model

Art. 4881

Es. - hex. mm. 13 x 11 x 21
**VESPA SUPER - SPRINT
PX - PE** model

Art. 4863

L = mm. 46 Es. - hex. mm. 13 X 21

**CHIAVE CANDELA A PIPA
CLE A BOUGIE A CANNE
PIPE SPARK PLUG SPANNER**



Art. 4802

CHIAVE PER CANDELE DA 21 mm.

**CLE A BOUGIES 21 mm. POUR
CYCLOMOTEUR**

**21 mm. MOPEDS SPARK PLUGS
SPANNER**

Tube rinforzato - Tube renforcé -
Reinforced pipe



Art. 4804

CHIAVE PER CANDELE DA 21 mm CON MANICO PIEGATO

CLE A BOUGIES DE 21 mm AVEC MANCHE PLIE

21 mm SPARK PLUGS SPANNER WITH FOLDED HANDLE

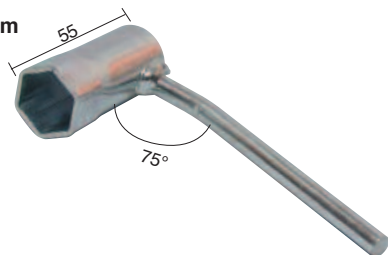

Art. 4807

CHIAVE PER CANDELE STANDARD DA 21 mm.

CLE A BOUGIES STANDARD 21 mm.

21 mm. STANDARD SPARK PLUGS SPANNER

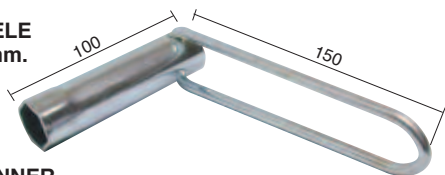

Art. 4835

SPINA PER CHIAVI CANDELA

PIVOT POUR CLES A BOUGIE

PIN FOR SPARK PLUG SPANNERS

Conf. / Pack 5 pcs

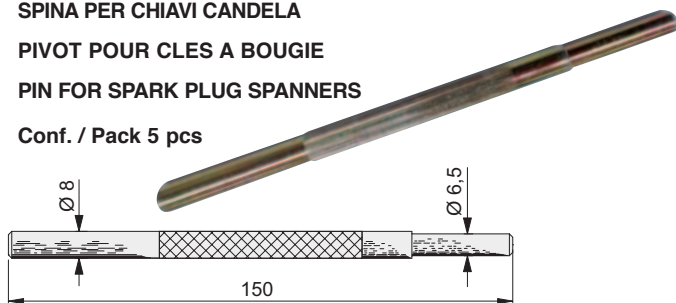

CHIAVI CANDELA STANDARD

CLES A BOUGIE STANDARD

STANDARD SPARK PLUG SPANNERS

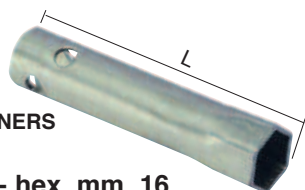

Art. 4810 L= 90 Es. - hex. mm. 16

Art. 4811 L=100 Es. - hex. mm. 18

Art. 4812 L=120 Es. - hex. mm. 21

Art. 4814 L=140 Es. - hex. mm. 16

Art. 4818

CHIAVE CANDELA A **DOPIO ESAGONO**

CLE A BOUGIE A **DOUBLE HEXAGONE**

DOUBLE HEXAGON SPARK PLUG SPANNER

L=120 Es. - hex. mm. 16 - 18

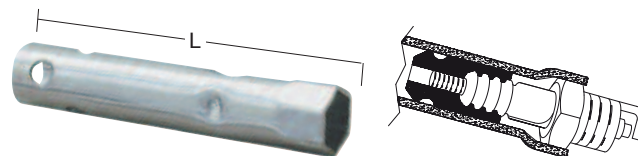
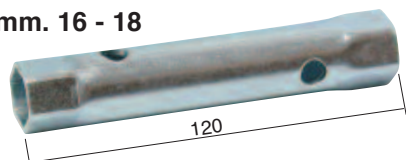

CHIAVI CANDELA STANDARD **CON GOMMINO**

CLES A BOUGIE STANDARD **AVEC CAOUTCHOUC**

STANDARD SPARK PLUG SPANNERS **WITH RUBBER**

Art. 4824 L= mm. 80 Es. - hex. mm. 16

Art. 4825 L= mm. 100 Es. - hex. mm. 16

Art. 4839 L= mm. 190 Es. - hex. mm. 16
EXTRA LONG

Art. 4826 L=mm. 90 Es. - hex. mm. 13

Art. 4834 L= mm. 135 Es. - hex. mm. 13

Art. 4830 L= mm. 120 Es. - hex. mm. 18

Art. 4842

CHIAVE CANDELA DA 14 mm MOD. HONDA CON GOMMINO E PUNTALE ESAGONALE

CLE A BOUGIE DE 14 mm MOD. HONDA AVEC CAOUTCHOUC ET EMBOUT FILETE

14 mm MOD. HONDA SPARK PLUG SPANNER WITH RUBBER AND HEXAGONAL PUSH ROD

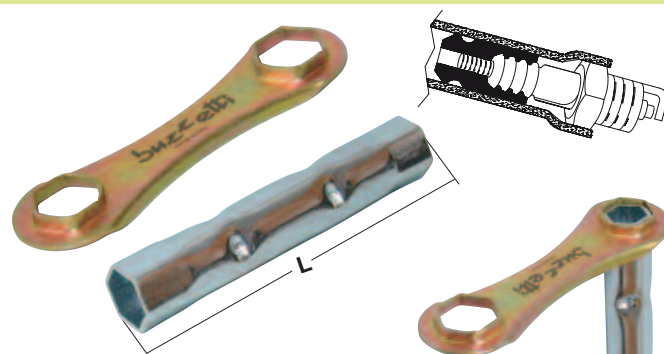
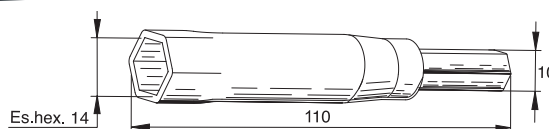
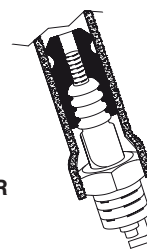

CHIAVI CANDELA A **DOPIO ESAGONO** CON LEVA DI MANOVRA E GOMMINI

CLES A BOUGIE A **DOUBLE HEXAGONE** AVEC LEVIER DE MANOEUVRE ET CAOUTCHOUC

DOUBLE HEXAGON SPARK PLUG SPANNERS WITH WORKING HANDLE AND RUBBERS

Art. 4854 L= mm.120 Es. - hex. mm. 16 - 18

Art. 4856 L= mm.140 Es. - hex. mm. 16 - 18