

ATTREZZI PER - OUTILS POUR
TOOLS FOR - WERKZEUGE FÜR
PIAGGIO - VESPA - APRILIA - GILERA

buzetti®

Art. **5232**

ESTRATTORE VOLANO
ARRACHE VOLANT
FLY-WHEEL PULLER

Ø mm. 26 passo-pitch 1
KOKUSAN - MITSUBA -
PIAGGIO - VESPA 50cc 2t/4t
APRILIA - PEUGEOT - 50cc
2t / 4t

Conf. / Pack 2 pcs



Art. **5242**

ESTRATTORE VOLANO
ARRACHE VOLANT
FLY-WHEEL PULLER

PIAGGIO-GILERA
50/125/150/200 2t - 4t
LML - 125 - 150 - 200

MOTOPLATT, Ø mm. 28 passo 1.
Fly-wheel puller, MOTOPLATT type,
Ø mm. 28 pitch 1.

Conf. / Pack 2 pcs



Art. **5255**

CIAO - SI

Estrattore volano Ø mm. 17 passo1.
Fly-wheel extractor Ø mm.17 pitch 1.

Conf. / Pack 1 pc



Art. **5260**

VESPA PK

Estrattore volano Ø mm. 24 passo 1.
Fly-wheel puller Ø mm. 24 pitch 1.

Conf. / Pack 1 pc



Art. **5283**

ESTRATTORE CON DOPPIO FILETTO ESTERNO DESTRO
ARRACHE VOLANT AVEC DOUBLE FILET EXTERNE DROITE
PULLER WITH DOUBLE RIGHT OUTER THREAD

Ø mm 26 x 1 Ø mm 28 x 1

PER/POUR/FOR **PIAGGIO-VESPA 125/150 2t-4t**

Conf. / Pack 2 pcs



Art. **5336**

ESTRATTORE VOLANO - ARRACHE VOLANT - FLY-WHEEL PULLER

Ø mm 35 x 1

FILETTO INTERNO - FILET INTERIEUR -
INTERNAL THREAD

per motori / pour moteurs / for engines

PIAGGIO 250-300-400-500 4t

Conf. / Pack 1 pc



Art. **5337**

ESTRATTORE VOLANO FILETTO INTERNO
COMPLETO DI PUNTALE SPECIFICO

ARRACHE VOLANT FILET INTERIEUR
COMPLET DE EMBOUT SPÉCIFIQUE

FLY-WHEEL PULLER WITH INTERNAL THREAD
COMPLETE WITH SPECIFIC ROD

Ø mm 30 x 1

PER/POUR/FOR **VESPA PRIMAVERA 125-150cc**
dal/de/from 2014

VESPA SPRINT 125 - 150cc

PIAGGIO LIBERTY 125 - 150cc

MOTORI / MOTEURS / ENGINES 4T 3V

VALIDO ANCHE PER / VALIDE AUSSI POUR / VALID ALSO FOR
VESPA LX - S 125 - 150 4t

Conf./Pack 1 pc

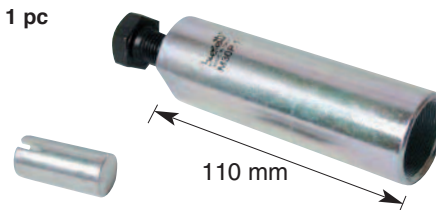

Art. **5421**

ESTRATTORE «VESPA»

Smontaggio frizione per 50/125, Primavera
ET3, PK tutti i modelli. Ø mm. 26 passo 1.

For clutch disassembly for 50/125 Primavera,
ET3, PK all models. Ø mm. 26 passo 1.

Conf. / Pack 2 pcs

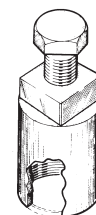

Art. **5424**

VESPA 50/125/150/200 APE
(O.R. 0030631)

Spingidischi per smontaggio
frizione tipo professionale.

Plate pushing tool for clutch
disassembly professional model.

Conf. / Pack 1 pc

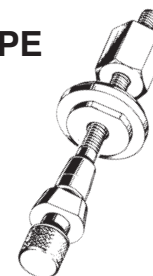

Art. **5429**

VESPA PX - PE
(O.R. TOC30627)

Attrezzo per smontaggio ghiera frizione.

Tool for disassembly clutch ring nut.

Conf. / Pack 1 pc

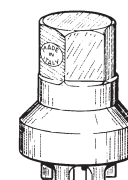

Art. 5433

VESPA

Attrezzo smontaggio rubinetto benzina tutti i modelli.

Tool for disassembly petrol twist grips all models.

Conf. / Pack 1 pc

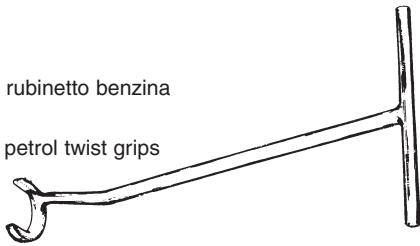

ATTREZZO PER SERRAGGIO GHIERA STERZO

OUTIL POUR SERRER L'ECROU DE DIRECTION

TOOL FOR TIGHTENING THE STEERING NUT



Art. 5419

SCOOTERS PIAGGIO GILERA

TUTTI I MODELLI / TOUS LES MODELES / ALL MODELS

ATTREZZI PER LO SMONTAGGIO DEI FILTRI OLIO MOTORE - INNESTO QUADRO

OUTILS POUR FILTRE A HUILE - GREFFE CARRÉE
OIL FILTER TOOLS - SQUARE CLUTCH

Art. 5186

PER FILTRI Ø 76 CON 14 ANGOLI
POUR FILTRES Ø 76 AVEC 14 PANS
FOR FILTERS Ø 76 WITH 14 FLUTES
VALIDO PER / VALIDE POUR / VALID FOR
BMW - PIAGGIO



Art. 5197

PER / POUR / FOR **BMW**
ANCHE PER/AUSSI POUR/ALSO FOR **GUZZI - PIAGGIO**

PER FILTRI Ø 76 CON 12 INNESTI RIGATI
POUR FILTRES Ø 76 AVEC 12 GREFFES RAYÉS
FOR FILTERS Ø 76 WITH 12 SCORED CLUTCHES

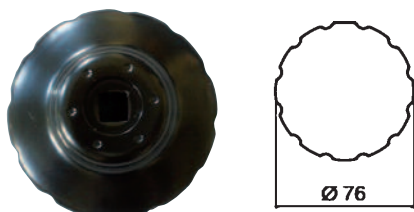

Art. 5106

SCOOTER APRILIA - MALAGUTI - PEUGEOT - PIAGGIO - GILERA - VESPA

ATTREZZO PER FILTRO MOTORI PIAGGIO 300-400-500cc 4t. A DOPPIO USO, PER CARTUCCE POLIGONALI E A INNESTI RIGATI

OUTIL POUR FILTRE MOTEURS PIAGGIO 300-400-500cc 4t A DOUBLE USAGE, POUR LES CARTOUCHES POLYGONALES ET A GREFFES RAYES

PIAGGIO 300-400-500cc 4s ENGINES FILTER TOOL WITH DOUBLE USE, FOR SCORED CLUTCHES AND POLYGONAL CARTRIDGES

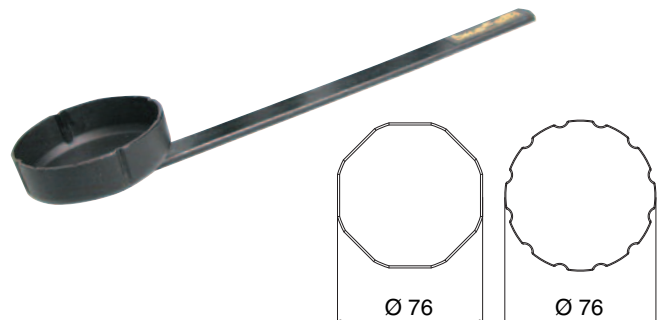

Art. 5110

ATTREZZO SMONTA FILTRO OLIO SUI MOTORI PIAGGIO da 125 a 300 cc. 4t

CARTUCCIA FILTRO DI Ø 49 mm CON 14 INNESTI

OUTIL DÉMONTE FILTRE HUILE SUR MOTEURS PIAGGIO de 125 à 300 cc. 4t

CARTOUCHE FILTRE DE Ø 49 MM AVEC 14 PANS

PIAGGIO ENGINES from 125 to 300 cc 4s OIL FILTER DISASSEMBLING TOOL
Ø 49 mm - 14 FLUTES FILTER CARTRIDGES



Art. 5112

SCOOTER APRILIA - MALAGUTI - PEUGEOT - PIAGGIO - GILERA - VESPA

ATTREZZO PER FILTRO MOTORI PIAGGIO da 125 a 250 cc.

OUTIL POUR FILTRE MOTEURS PIAGGIO de 125 a 250 cc.

PIAGGIO ENGINES FROM 125 TO 250 cc. FILTER TOOL



ATTREZZI PER - OUTILS POUR TOOLS FOR - WERKZEUGE FÜR PIAGGIO - VESPA - APRILIA - GILERA

buzzetti®

Art. 5426

ATTREZZO BLOCCA FRIZIONE CON ESAGONO
OUTIL BLOQUE EMBRAYAGE AVEC HEXAGONE
TOOL TO LOCK THE CLUTCH WITH HEXAGON

PIAGGIO - GILERA SFERA - ZIP - QUARTZ

3 PIOLI / PIVOTS / PINS
ES./HEX. mm. 46

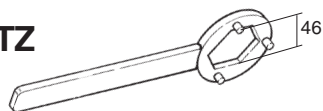

Art. 5427

ATTREZZO BLOCCA FRIZIONE CON ESAGONO
OUTIL BLOQUE EMBRAYAGE AVEC HEXAGONE
TOOL TO LOCK THE CLUTCH WITH HEXAGON

PIAGGIO - VESPA - GILERA APRILIA - 50 2t-4t

TUTTI I MODELLI / TOUS LES MODELES / ALL MODELS
ES./HEX. mm. 34

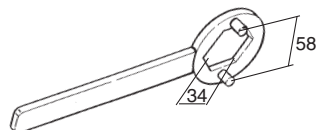

Art. 5437

ATTREZZO BLOCCA PULEGGIA ANTERIORE
OUTIL BLOQUE POULIE ANTÉRIEURE
FRONT PULLEY LOCKING TOOL

PER/POUR/FOR

VESPA PRIMAVERA 125-150cc VESPA SPRINT 125 - 150cc PIAGGIO LIBERTY 125 - 150cc

MOTORI / MOTEURS /
ENGINES 4T 3V

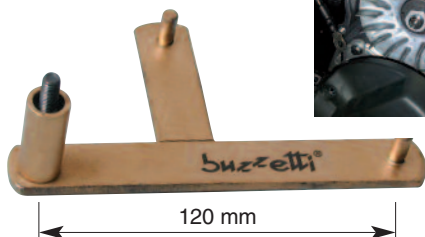

Art. 5440

ATTREZZO BLOCCA PULEGGIA ANTERIORE
OUTIL BLOQUE POULIE ANTÉRIEURE
FRONT PULLEY LOCKING TOOL

PER MOTORI / POUR MOTEURS / FOR ENGINES

PIAGGIO 125/150 4t 3V

LX-S

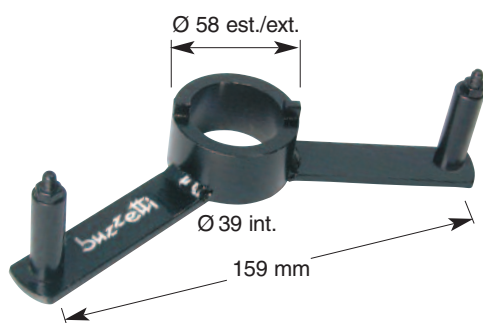

Art. 5442

ATTREZZO BLOCCA PULEGGIA ANTERIORE
OUTIL BLOQUE POULIE ANTÉRIEURE
FRONT PULLEY LOCKING TOOL

PER MOTORI / POUR MOTEURS / FOR ENGINES

PIAGGIO 250-300cc 4t LC - GTS - GTV / QUASAR APRILIA SPORT CITY 300cc 4t



Art. 5446

ATTREZZO BLOCCA PULEGGIA ANTERIORE
OUTIL BLOQUE POULIE ANTÉRIEURE
FRONT PULLEY LOCKING TOOL

PER MOTORI PIAGGIO 400-500cc 4t

POUR MOTEURS PIAGGIO 400-500cc 4t
FOR PIAGGIO 400-500cc 4s ENGINES

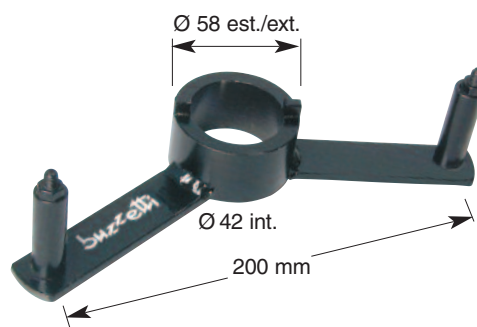

ATTREZZI BLOCCA PULEGGIA ANTERIORE
OUTILS BLOQUE POULIE ANTÉRIEURE
FRONT PULLEY LOCKING TOOLS



Art. 5425

PER MOTORI / POUR MOTEURS / FOR ENGINES

PIAGGIO 2t-4t DA/DE/ FROM 50 A/TO 125 cc

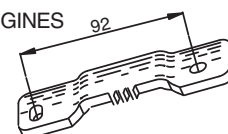

Art. 5430

PER MOTORI / POUR MOTEURS / FOR
ENGINES

PIAGGIO 125-150cc 4t

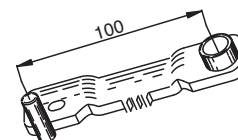

Art. 5526

**ATTREZZO BLOCCA PULEGGIA POSTERIORE SUI MOTORI HONDA 300cc 4t - YAMAHA 400-500cc 4t
PIAGGIO 300-400-500cc 4t
KYMCO - SYM**

**OUTIL POUR BLOQUER LA POULIE POSTERIEURE SUR MOTEURS HONDA 300cc 4t - YAMAHA 400-500cc 4t
PIAGGIO 300-400-500cc 4t
KYMCO - SYM**

**TOOL TO LOCK THE REAR PULLEY ON HONDA 300cc 4s
YAMAHA 400-500cc 4s
PIAGGIO 300-400-500cc 4s ENGINES
KYMCO - SYM**

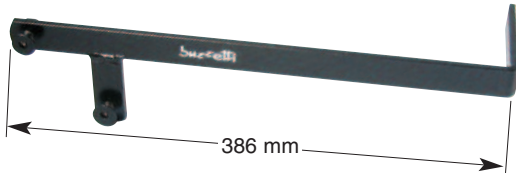

Art. 5428

ATTREZZO BLOCCA FRIZIONE per PIAGGIO 125-250-300-400cc 4t

OUTIL BLOQUE POULIE EMBRAYAGE pour PIAGGIO 125-250-300-400cc 4t

CLUTCH LOCKING TOOL for PIAGGIO 125-250-300-400cc 4s

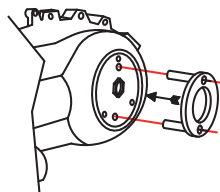

**CHIAVE PER DADO VARIATORE POSTERIORE
CLEF POUR ECROU VARIATEUR POSTERIEUR
REAR VARIATOR NUT WRENCH**

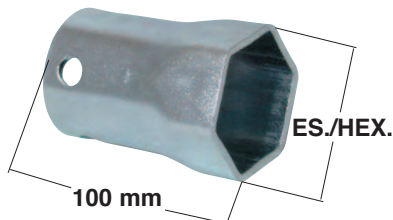

Art. 5445

**ES./HEX. mm. 46
per/pour/for PIAGGIO 250cc -
YAMAHA 125-150cc**

Art. 5449

**ES./HEX. mm. 55
per/pour/for PIAGGIO da/de/from 300cc a/à/to 500cc**

Art. 5658

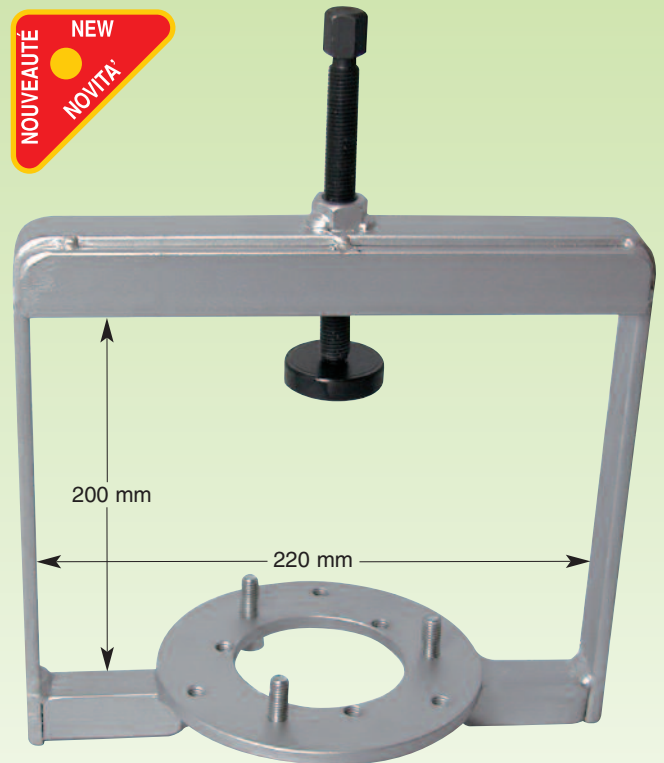

**ATTREZZO RITEGNO MOLLA FRIZIONE
OUTIL DE RETENTION RESSORT EMBRAYAGE
CLUTCH SPRING CHECK TOOL**

PER MOTORI / POUR MOTEURS / FOR ENGINES

PIAGGIO - VESPA

DA/DE/FROM **125cc** A/À/TO **500cc 4T**

Art. 5666

ATTREZZO PER METTERE IN CARICA LA MOLLA DEL SETTORE AVVIAMENTO

OUTIL POUR METTRE EN PLACE LA RESSORT DU SECTEUR DEMARREUR

TOOL TO REASSEMBLE THE START SHAFT SPRING

per/pour/for **PIAGGIO / VESPA**

Tutti i modelli 2 e 4t da 50 a 125cc

Tous les modèles 2 et 4t de 50 à 125cc

All models 2 and 4s from 50 to 125cc

per/pour/for **PEUGEOT SPEEDFIGHT 3**

