

**ATTREZZI PER BLOCCARE LA ROTAZIONE DELLA PULEGGIA ANTERIORE
OUTILS POUR BLOQUER LA ROTATION DE LA POULIE ANTÉRIEURE
FRONT PULLEY LOCKING TOOL - PREVENT PULLEY ROTATION**

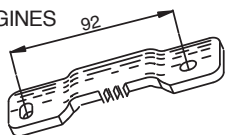

Art. 5425

PER MOTORI / POUR MOTEURS / FOR ENGINES
**PIAGGIO 2t-4t DA/DE/
FROM 50 A/TO 125 CC**

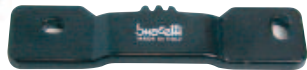

Art. 5430

PER MOTORI / POUR MOTEURS / FOR
ENGINES
PIAGGIO 125-150cc 4t

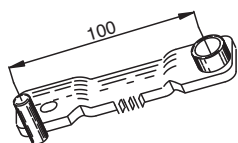

Art. 5458

PER MOTORI / POUR MOTEURS / FOR ENGINES
PEUGEOT KISBEE 50cc 4t

CON DISTANZIALE E BULLONCINO
AVEC ENTRETOISE ET PETIT BOULON
WITH SPACER AND SMALL BOLT

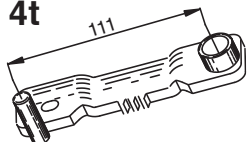

Art. 5468

PER MOTORI / POUR MOTEURS / FOR
ENGINES
PEUGEOT 50/100cc 2t

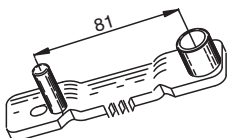

Art. 5580

PER MOTORI / POUR MOTEURS /
FOR ENGINES
KYMCO 50cc 2t

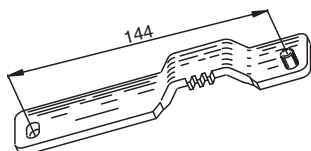

Art. 5582

PER MOTORI / POUR MOTEURS / FOR
ENGINES
KYMCO AGILITY 50 cc 4t

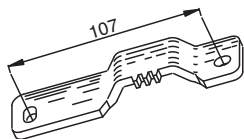

Art. 5454

PER MOTORI **SCOOTER 50cc 2t** DI **FABBRICAZIONE
CINESE** (MODELLO QJ)
POUR MOTEURS **SCOOTER 50cc 2t** DE **FABRICATION
CHINOISE** (MODELE QJ)
FOR **50cc 2s CHINESE SCOOTER ENGINES** (QJ MODEL)
MALAGUTI 50 AIR - CPI - KEEWAY - GENERIC
e altri / et autres / and others

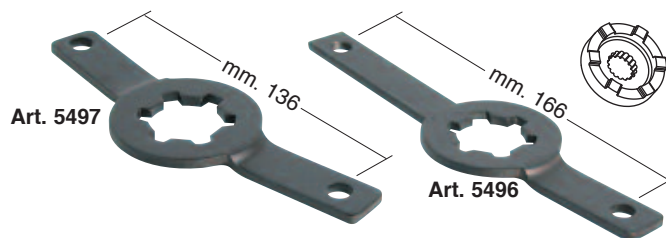

Art. 5496

MOTORI / MOTEURS / ENGINES
YAMAHA-MINARELLI 50cc 2t
CILINDRO ORIZZONTALE / CYLINDRE
HORIZONTAL / HORIZONTAL CYLINDER

Art. 5497

MOTORI / MOTEURS / ENGINES
YAMAHA-MINARELLI 50cc 2t
CILINDRO VERTICALE / CYLINDRE VERTICAL /
VERTICAL CYLINDER

Art. 5437

PER/POUR/FOR
VESPA PRIMAVERA 125-150cc
VESPA SPRINT 125 - 150cc
PIAGGIO LIBERTY 125 - 150cc
MOTORI / MOTEURS / ENGINES 4T 3V

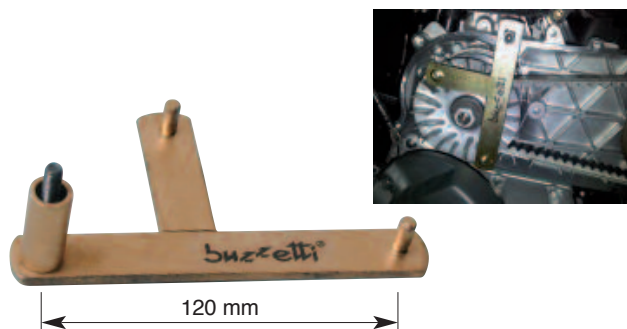

Art. 5440

PER MOTORI / POUR MOTEURS / FOR ENGINES
PIAGGIO 125/150 4t 3V
LX-S

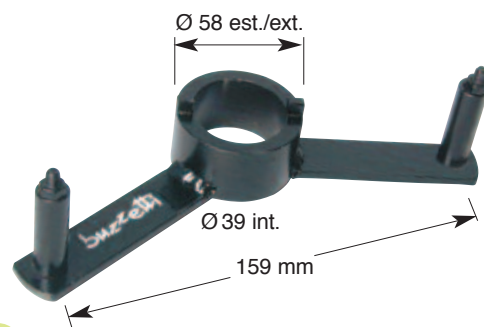

Art. 5442

PER MOTORI / POUR MOTEURS / FOR ENGINES
PIAGGIO 250-300cc 4t
LC - GTS - GTV / QUASAR
APRILIA SPORT CITY 300cc 4t



**ATTREZZI PER BLOCCARE LA ROTAZIONE DELLA PULEGGIA ANTERIORE
OUTILS POUR BLOQUER LA ROTATION DE LA POULIE ANTÉRIEURE
FRONT PULLEY LOCKING TOOL - PREVENT PULLEY ROTATION**

Art. 5446

PER MOTORI **PIAGGIO 400-500cc 4t**
POUR MOTEURS **PIAGGIO 400-500cc 4t**
FOR **PIAGGIO 400-500cc 4s** ENGINES

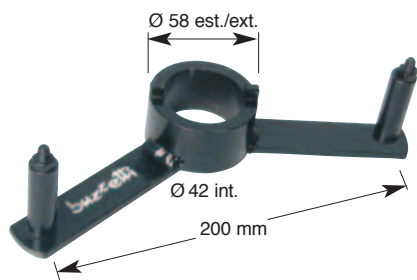

Art. 5462

PER MOTORI **SUZUKI 125/150cc 4t**
POUR MOTEURS **SUZUKI 125/150cc 4t**
FOR **SUZUKI 125/150cc 4t** ENGINES
SCOOTER SIXTEEN

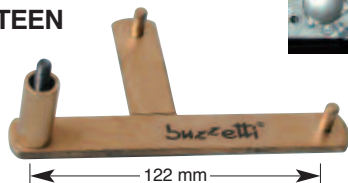

Art. 5512

PER MOTORI **YAMAHA-MINARELLI 50cc 4t**
POUR MOTEURS **YAMAHA-MINARELLI 50cc 4t**
FOR **YAMAHA-MINARELLI 50cc 4s** ENGINES

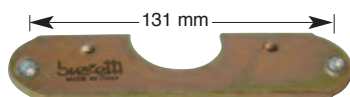

Art. 5516

PER MOTORI / POUR MOTEURS / FOR ENGINES
YAMAHA XENTER 125 / 150cc 4t

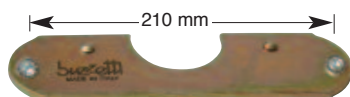

Art. 5509

PER MOTORI / POUR MOTEURS / FOR ENGINES
SYM 50cc 4T - FIDDLE - SYMPHONY
PEUGEOT TWEET 50cc

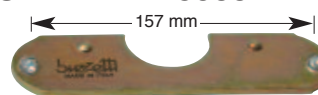

Art. 5520

PER MOTORI / POUR MOTEURS / FOR ENGINES
PEUGEOT TWEET 125/150
SYM 125/150 4t - SYMPHONY
E ALTRI / ET OUTRES / AND OTHERS

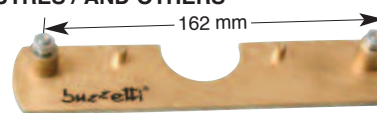

Art. 5534

PER MOTORI / POUR MOTEURS / FOR ENGINES
HONDA ZOOMER/RUCKUS 50cc 4t

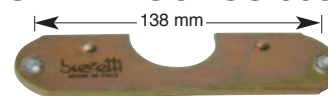

Art. 5554

PER MOTORI / POUR MOTEURS / FOR ENGINES
HONDA - HONDA SH 125/150
KYMCO - KEEWAY
CPI/GENERIC 6 MARCE / 6 VITESSES / 6 GEARS
Scoter 50/125/150/300 2t-4t

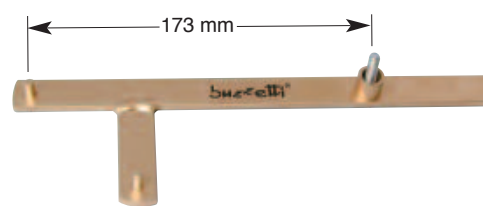

**ATTREZZO BLOCCA VOLANO MAGNETICO
OUTIL BLOQUE VOLANT MAGNETIQUE
TOOL TO LOCK THE MAGNETIC FLY-WHEEL**

Art. 5504

YAMAHA - MINARELLI 50/100 2t
PEUGEOT 50 2t



**ATTREZZI PER IL BLOCCAGGIO DELLA ROTAZIONE DELLA CAMPANA FRIZIONE,
DELLA PULEGGIA ANTERIORE E DEL VOLANO**
OUTILS POUR LE BLOCAGE DE LA BOÎTE DE VITESSE, DE LA POULIE ANTÉRIEURE ET DU VOLANT
CLUTCH PULLEY, FRONT PULLEY AND FLYWHEEL LOCKING TOOL



Art. 5636

ATTREZZO CON DENTELLI PIATTI E DENTELLI TONDI DA Ø 8MM
CON BLOCCAGGIO DELL'APERTURA
CAPACITA' MAX. 130mm
PESO 0,750 KG

OUTIL DE BLOCAGE AVEC BECS PLATS ET ERGOTS
CIRCULAIRES DE Ø 8mm
CAPACITÉ MAXI 130mm
POIDS 0,750 KG

HOLDING TOOL WITH FLAT NOTCHES AND CIRCULAR TEETH
OF Ø 8mm
130mm MAX. CAPACITY
WEIGHT 0,750 KG

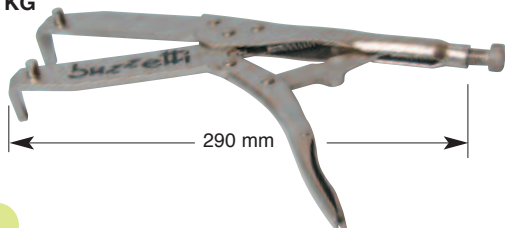

Art. 5637

ATTREZZO UNIVERSALE CON DENTELLI DA Ø 5mm E Ø 9mm
CAPACITA' MAX. 140mm
PESO 0,485 KG

OUTIL UNIVERSEL AVEC ERGOTS DE Ø 5mm ET Ø 9mm
CAPACITÉ MAXI 140mm
POIDS 0,485 KG

UNIVERSAL TOOL WITH Ø 5mm AND Ø 9mm NOTCHES
140mm MAX. CAPACITY
WEIGHT 0,485 KG

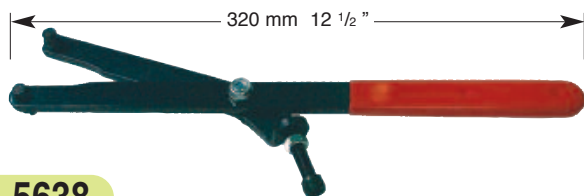

Art. 5638

ATTREZZO CON DENTELLI A SMUSSO PER BLOCCARE LA
ROTAZIONE DI CORPI DENTATI
CAPACITA' MAX. 125 MM
PESO 0,620 KG

OUTIL AVEC BECS ARRONDIS POUR BLOQUER LA ROTATION
DES CORPS DENTELÉS
CAPACITÉ MAXI 125 MM
POIDS 0,620 KG

TOOL WITH BLUNTED NOTCHES TO LOCK THE ROTATION OF
TOOTHED PARTS
125 MM MAX. CAPACITY
WEIGHT 0,620 KG

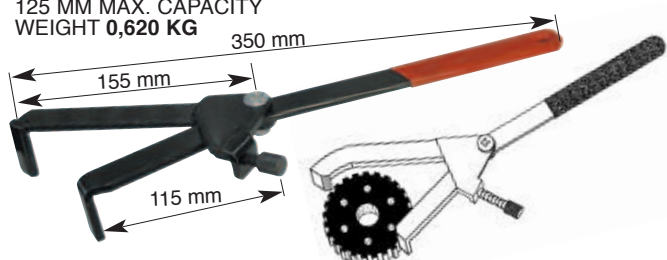

Art. 5528

PER/POUR/FOR
YAMAHA TMAX 500 - 530

ATTREZZO CON 4 PIOLI PER BLOCCARE LA PULEGGIA
POSTERIORE E 2 PIOLI PER LA PULEGGIA ANTERIORE
PESO 1.000 KG

OUTIL AVEC 4 PIVOTS POUR BLOQUER LA POULIE
POSTÉRIEURE ET 2 PIVOTS POUR LA POULIE ANTÉRIEURE
POIDS 1.000 KG

TOOL WITH 4 PINS TO LOCK THE REAR PULLEY AND 2 PINS
FOR THE FRONT PULLEY
WEIGHT 1.000 KG

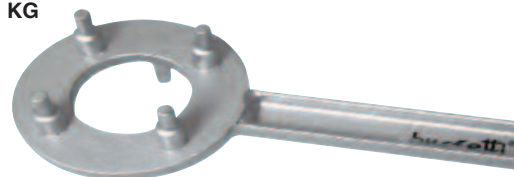

Art. 5530

PER/POUR/FOR
YAMAHA TMAX 500 - 530

ROBUSTO ATTREZZO CON PIOLI DA Ø 10 E Ø 7 PER
BLOCCARE LA ROTAZIONE DEL ROTORE O DELLA FRIZIONE
CAPACITÀ MAX 140 mm
PESO 0,630 KG

SOLIDE OUTIL AVEC PIVOTS DE Ø 10 ET Ø 7 POUR BLOQUER
LA ROTATION DU ROTOR OU DE L'EMBRAYAGE
CAPACITÉ MAXI 140 mm
POIDS 0,630 KG

STRONG TOOL WITH PINS Ø 10 AND Ø 7 TO LOCK ROTOR OR
CLUTCH ROTATION
140 mm MAX CAPACITY
WEIGHT 0,630 KG

VALIDO PER MOTORI DA 500 A 800cc
VALIDE POUR MOTEURS DE 500 À 800cc
VALID FOR ENGINES FROM 500 TO 800cc

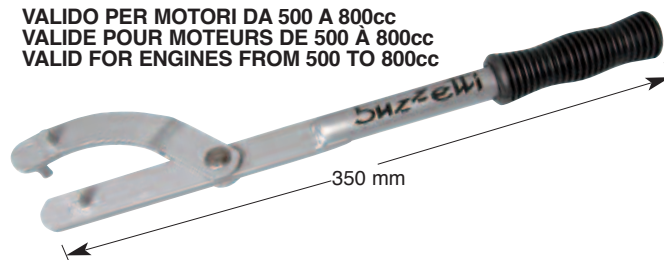

Art. 0312

ATTREZZO PER LA REGOLAZIONE DELLA TENSIONE DELLE
CINGHIE DENTATE

VEDERE PAG. 10

ISTRUZIONI CON L'ATTREZZO

OUTIL POUR AJUSTER LA TENSION DES COURROIES
DENTELÉES TRANSMISSION

VOIR PAGE 10

MODE D'EMPLOI AVEC L'OUTIL

TENSIONING GAUGE TOOL FOR
TIMING BELTS

SEE PAGE 10

USER INSTRUCTIONS
INCLUDED



Art. 5633

ATTREZZO UNIVERSALE PER IL BLOCCAGGIO DELLA ROTAZIONE DELLA CAMPANA FRIZIONE PER SCOOTER DA 125cc A 500cc
CAPACITA' DA Ø 100 A Ø 255 MM

OUTIL UNIVERSEL POUR LE BLOCAGE DE LA ROTATION DE LA POULIE DE L'EMBRAYAGE POUR SCOOTER DE 125cc A 500cc

CAPACITE DE Ø 100 A Ø 255 MM

UNIVERSAL TOOL TO HOLD CLUTCH PULLEY ROTATION FOR SCOOTER FROM 125cc TO 500cc

CAPACITY FROM Ø 100 TO Ø 255 MM

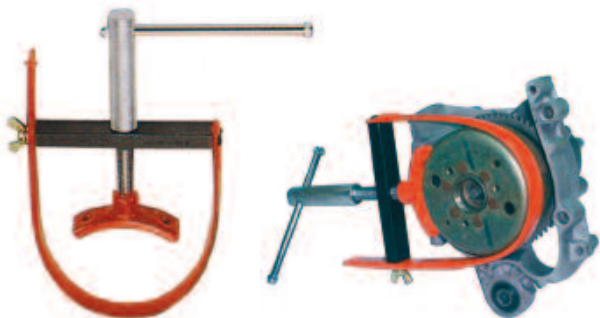

Art. 5635

ATTREZZO UNIVERSALE PER IL BLOCCAGGIO DELLA ROTAZIONE DELLA CAMPANA FRIZIONE DA 50cc A 125cc
CAPACITÀ DA Ø 45 A Ø 120mm

OUTIL UNIVERSEL POUR LE BLOCAGE DE LA ROTATION DE LA POULIE DE L'EMBRAYAGE DE 50cc A 125cc
CAPACITE DE Ø 45 A Ø 120mm

UNIVERSAL TOOL TO HOLD CLUTCH PULLEY ROTATION FROM 50cc TO 125cc

CAPACITY FROM Ø 45 TO Ø 120mm

Art. 5428

ATTREZZO BLOCCA FRIZIONE per PIAGGIO 125-250-300cc 4t

OUTIL BLOQUE POULIE EMBRAYAGE pour PIAGGIO 125-250-300cc 4t

CLUTCH LOCKING TOOL for PIAGGIO 125-250-300cc 4s

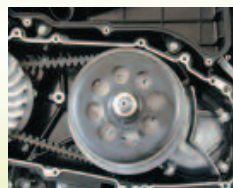

ATTREZZO BLOCCA FRIZIONE CON ESAGONO

OUTIL BLOQUE EMBRAYAGE AVEC HEXAGONE

TOOL TO LOCK THE CLUTCH WITH HEXAGON

Art. 5560

HONDA - HONDA SH 125 / 150
KYMCO - KEEWAY - SYM
CPI/GENERIC
Scooter 50/125/150 2t-4t

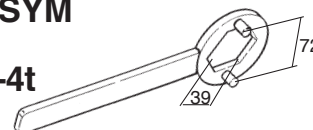

Art. 5427

PIAGGIO - VESPA - GILERA
APRILIA - 50 2t-4t
TUTTI I MODELLI / TOUS LES MODELES / ALL MODELS
ES./HEX. mm. 34

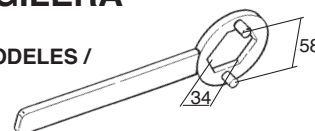

Art. 5476

YAMAHA - MBK 50 2t
MALAGUTI 50 2t - KYMCO 50 2t-4t
PEUGEOT 50 2t
SUZUKI 50 2t
ES./HEX. mm. 39

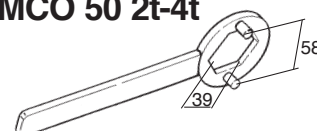

Art. 5495

YAMAHA - MBK 50 2t
MALAGUTI 50 2t - KYMCO 50 2t
PEUGEOT 50 2t
SUZUKI 50 2t
ES./HEX. mm. 38

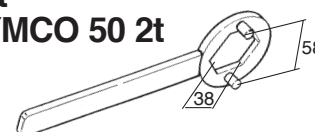

Art. 5499

YAMAHA - MBK 50 2t
MALAGUTI 50 2t - KYMCO 50 2t
PEUGEOT 50 2t
SUZUKI 50 2t
ES./HEX. mm 41

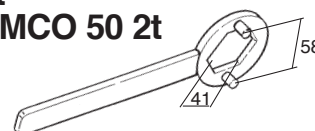

Art. 5506

Per motori / pour moteurs / for YAMAHA - MINARELLI engines
scooter 125/150/200 4t
YAMAHA XENTER 125/150
ES./HEX. mm 46

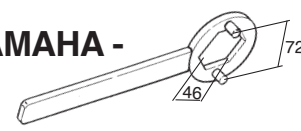

**CHIAVE PER DADO VARIATORE POSTERIORE
CLEF POUR ECROU VARIATEUR POSTERIEUR
REAR VARIATOR NUT WRENCH**

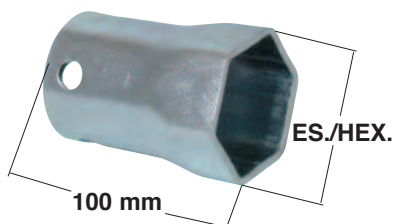

Art. **5445**

ES./HEX. mm. 46
per/pour/for **PIAGGIO 250cc -
YAMAHA 125-150cc**

Art. **5449**

ES./HEX. mm. 55
per/pour/for **PIAGGIO** da/de/from 300cc a/à/to 500cc

**RITEGNO MOLLA FRIZIONE
RETENTION RESSORT EMBRAYAGE
CLUTCH SPRING TOOL**

Art. **5650**

ATTREZZO RITEGNO MOLLA FRIZIONE PER MOTORI CON
PULEGGIA Ø mm 125 MAX.

OUTIL DE RETENTION RESSORT EMBRAYAGE POUR MOTEURS
AVEC POULIE Ø mm 125 MAX.

CLUTCH SPRING CHECK-TOOL FOR ENGINES WITH Ø mm
125 MAX PULLEY.

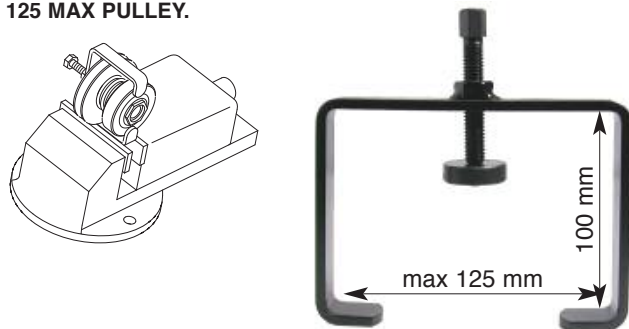

Art. **5654**

ATTREZZO RITEGNO MOLLA FRIZIONE PER MOTORI CON
PULEGGIA Ø mm 155 MAX.

OUTIL DE RETENTION RESSORT EMBRAYAGE POUR MOTEURS
AVEC POULIE Ø mm 155 MAX.

CLUTCH SPRING CHECK-TOOL FOR ENGINES WITH Ø mm 155
MAX PULLEY.

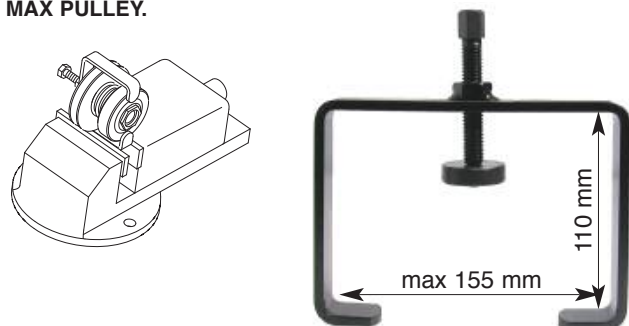

Art. **5656**

ATTREZZO RITEGNO MOLLA FRIZIONE PER MOTORI CON
PULEGGE GRANDI

OUTIL DE RETENTION RESSORT EMBRAYAGE POUR
MOTEURS AVEC GRANDES POULIES

CLUTCH SPRING CHECK-TOOL FOR ENGINES WITH BIG PULLEYS

CAPACITA' / CAPACITE / CAPACITY 220mm

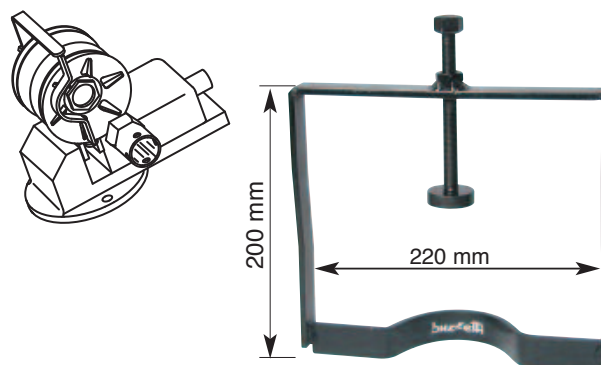

Art. **5658**

ATTREZZO RITEGNO MOLLA FRIZIONE
OUTIL DE RETENTION RESSORT EMBRAYAGE
CLUTCH SPRING CHECK TOOL

PER MOTORI / POUR MOTEURS / FOR ENGINES

PIAGGIO - VESPA

DA/DE/FROM **125cc** A/À/TO **500cc 4T**

